

BiHiKu

HIGH POWER BIFACIAL POLY PERC MODULE

390 W ~ 415 W

UP TO 30% MORE POWER FROM THE BACK SIDE

CS3W-390 | 395 | 400 | 405 | 410 | 415PB-AG (IEC1500 V)

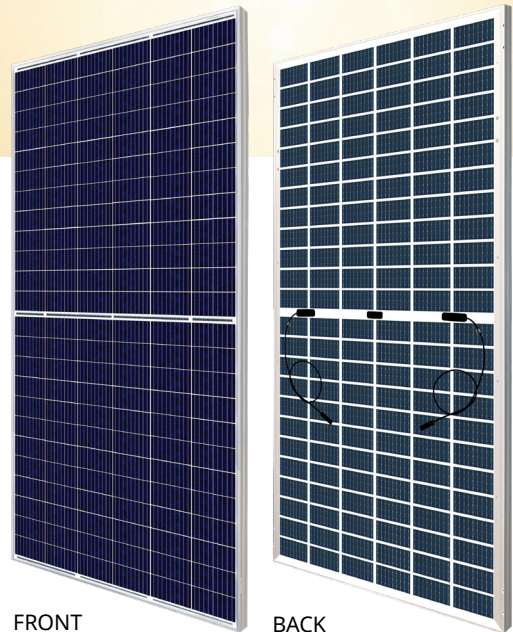

MORE POWER

- 

Up to 30% more power from the back side
- 

24 % higher front side power than conventional modules
- 

Low NMOT: 41 ± 3 °C
Low temperature coefficient (Pmax): -0.36 % / °C
- 

Better shading tolerance

MORE RELIABLE

- 

Lower internal current, lower hot spot temperature
- 

Minimizes micro-crack impacts
- 

Heavy snow load up to 5400 Pa, wind load up to 3600 Pa *



Linear Power Performance Warranty*

12 Years Enhanced Product Warranty on Materials and Workmanship*

1st year power degradation no more than 2%

Subsequent annual power degradation no more than 0.45%

*According to the applicable Canadian Solar Limited Warranty Statement.

MANAGEMENT SYSTEM CERTIFICATES*

ISO 9001:2015 / Quality management system
ISO 14001:2015 / Standards for environmental management system
ISO 45001: 2018 / International standards for occupational health & safety

PRODUCT CERTIFICATES*

IEC 61215 / IEC 61730 / CE / MCS / INMETRO
CEC listed (US California) / FSEC (US Florida)
UL 61730 / IEC 61701 / IEC 62716 / IEC 60068-2-68

Take-e-way

Canadian Solar recycles panels at the end of life cycle



* The specific certificates applicable to different module types and markets will vary, and therefore not all of the certifications listed herein will simultaneously apply to the products you order or use. Please contact your local Canadian Solar sales representative to confirm the specific certificates available for your product and applicable in the regions in which the products will be used.

CSI Solar Co., Ltd. is committed to providing high quality solar products, solar system solutions and services to customers around the world. Canadian Solar was recognized as the No. 1 module supplier for quality and performance/price ratio in the IHS Module Customer Insight Survey, and is a leading PV project developer and manufacturer of solar modules, with over 50 GW deployed around the world since 2001.

* For detailed information, please refer to Installation Manual.

ENGINEERING DRAWING (mm)

Rear View

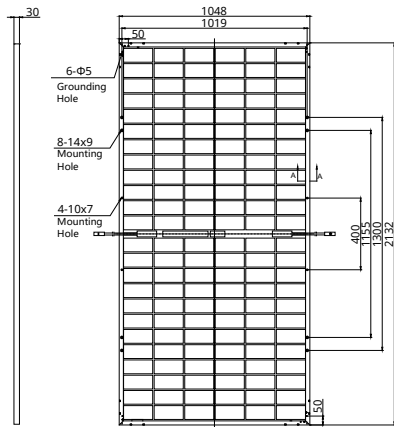

Frame Cross Section A-A

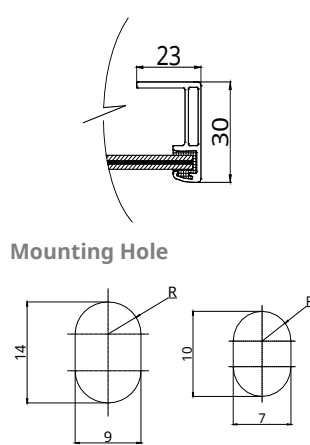

CS3W-400PB-AG / I-V CURVES

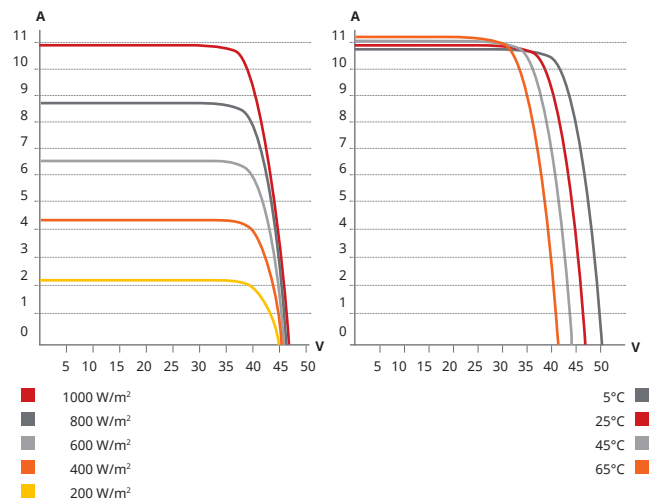

ELECTRICAL DATA | STC*

	Nominal Max. Power (Pmax)	Opt. Operating Voltage (Vmp)	Opt. Operating Current (Imp)	Open Circuit Voltage (Voc)	Short Circuit Current (Isc)	Module Efficiency
CS3W-390PB-AG	390 W	38.3 V	10.19 A	46.8 V	10.74 A	17.5%
Bifacial Gain**	5%	410 W	38.3 V	10.71 A	46.8 V	18.3%
	10%	429 W	38.3 V	11.21 A	46.8 V	19.2%
	20%	468 W	38.3 V	12.23 A	46.8 V	20.9%
	30%	507 W	38.3 V	13.25 A	46.8 V	22.7%
CS3W-395PB-AG	395 W	38.5 V	10.26 A	47 V	10.82 A	17.7%
Bifacial Gain**	5%	415 W	38.5 V	10.78 A	47 V	18.6%
	10%	435 W	38.5 V	11.3 A	47 V	19.5%
	20%	474 W	38.5 V	12.31 A	47 V	21.2%
	30%	513 W	38.5 V	13.34 A	47 V	23.0%
CS3W-400PB-AG	400 W	38.7 V	10.34 A	47.2 V	10.9 A	17.9%
Bifacial Gain**	5%	420 W	38.7 V	10.86 A	47.2 V	18.8%
	10%	440 W	38.7 V	11.37 A	47.2 V	19.7%
	20%	480 W	38.7 V	12.41 A	47.2 V	21.5%
	30%	520 W	38.7 V	13.44 A	47.2 V	23.3%
CS3W-405PB-AG	405 W	38.9 V	10.42 A	47.4 V	10.98 A	18.1%
Bifacial Gain**	5%	425 W	38.9 V	10.94 A	47.4 V	19.0%
	10%	445 W	38.9 V	11.46 A	47.4 V	19.9%
	20%	486 W	38.9 V	12.5 A	47.4 V	21.8%
	30%	527 W	38.9 V	13.56 A	47.4 V	23.6%
CS3W-410PB-AG	410 W	39.1 V	10.49 A	47.6 V	11.06 A	18.3%
Bifacial Gain**	5%	431 W	39.1 V	11.03 A	47.6 V	19.3%
	10%	451 W	39.1 V	11.54 A	47.6 V	20.2%
	20%	492 W	39.1 V	12.59 A	47.6 V	22.0%
	30%	533 W	39.1 V	13.64 A	47.6 V	23.9%
CS3W-415PB-AG	415 W	39.3 V	10.56 A	47.8 V	11.14 A	18.6%
Bifacial Gain**	5%	436 W	39.3 V	11.10 A	47.8 V	19.5%
	10%	457 W	39.3 V	11.63 A	47.8 V	20.5%
	20%	498 W	39.3 V	12.67 A	47.8 V	22.3%
	30%	540 W	39.3 V	13.75 A	47.8 V	24.2%

* Under Standard Test Conditions (STC) of irradiance of 1000 W/m², spectrum AM 1.5 and cell temperature of 25°C. Measurement uncertainty: ±3% (Pmax).

** Bifacial Gain: The additional gain from the back side compared to the power of the front side at the standard test condition. It depends on mounting (structure, height, tilt angle etc.) and albedo of the ground.

ELECTRICAL DATA

Operating Temperature	-40°C ~ +85°C
Max. System Voltage	1500 V (IEC/UL) or 1000 V (UL)
Module Fire Performance	TYPE 29 (UL 61730) or CLASS C (IEC61730)
Max. Series Fuse Rating	25 A
Application Classification	Class A
Power Tolerance	0 ~ + 5 W
Power Bifaciality*	70 %

* Power Bifaciality = $P_{max, rear} / P_{max, front}$, both $P_{max, rear}$ and $P_{max, front}$ are tested under STC, Bifaciality Tolerance: ± 5 %

* The specifications and key features contained in this datasheet may deviate slightly from our actual products due to the on-going innovation and product enhancement. CSI Solar Co., Ltd. reserves the right to make necessary adjustment to the information described herein at any time without further notice. Please be kindly advised that PV modules should be handled and installed by qualified people who have professional skills and please carefully read the safety and installation instructions before using our PV modules.

ELECTRICAL DATA | NMOT*

	Nominal Max. Power (Pmax)	Opt. Operating Voltage (Vmp)	Opt. Operating Current (Imp)	Open Circuit Voltage (Voc)	Short Circuit Current (Isc)
CS3W-390PB-AG	292 W	35.8 V	8.15 A	44.1 V	8.66 A
CS3W-395PB-AG	295 W	36.0 V	8.21 A	44.3 V	8.72 A
CS3W-400PB-AG	299 W	36.2 V	8.27 A	44.5 V	8.79 A
CS3W-405PB-AG	303 W	36.3 V	8.33 A	44.7 V	8.85 A
CS3W-410PB-AG	307 W	36.5 V	8.39 A	44.8 V	8.92 A
CS3W-415PB-AG	310 W	36.7 V	8.45 A	45.0 V	8.98 A

* Under Nominal Module Operating Temperature (NMOT), irradiance of 800 W/m², spectrum AM 1.5, ambient temperature 20°C, wind speed 1 m/s.

MECHANICAL DATA

Specification	Data
Cell Type	Poly-crystalline
Cell Arrangement	144 [2 X (12 X 6)]
Dimensions	2132 × 1048 × 30 mm (83.9 × 41.3 × 1.2 in)
Weight	28.4 kg (62.6 lbs)
Front / Back Glass	2.0 mm heat strengthened glass
Frame	Anodized aluminium alloy
J-Box	IP68, 3 diodes
Cable	4.0 mm ² (IEC), 12 AWG (UL)
Cable Length (Including Connector)	400 mm (15.7 in) (+) / 280 mm (11.0 in) (-) or customized length*
Connector	T4-PC-1 (IEC 1500 V) or T4-PPE-1 (IEC 1500 V) or PV-KST4-EVO2/XY, PV-KBT4-EVO2/XY (IEC 1500 V) or UTXCFA4AM, UTXCMA4AM (IEC 1500 V)
Per Pallet	33 pieces
Per Container (40' HQ)	660 pieces

* For detailed information, please contact your local Canadian Solar sales and technical representatives.

TEMPERATURE CHARACTERISTICS

Specification	Data
Temperature Coefficient (Pmax)	-0.36 % / °C
Temperature Coefficient (Voc)	-0.28 % / °C
Temperature Coefficient (Isc)	0.05 % / °C
Nominal Module Operating Temperature	41 ± 3°C

PARTNER SECTION



Canadian Solar MSS (Australia) Pty Ltd.

44 Stephenson St, Cremorne VIC 3121, Australia, sales.au@csisolar.com, www.csisolar.com/au

Apr. 2021. All rights reserved, PV Module Product Datasheet V5.6C1_AU
* Manufactured and assembled in China, Thailand and Vietnam.